

DATASHEET – DIMENSIONS

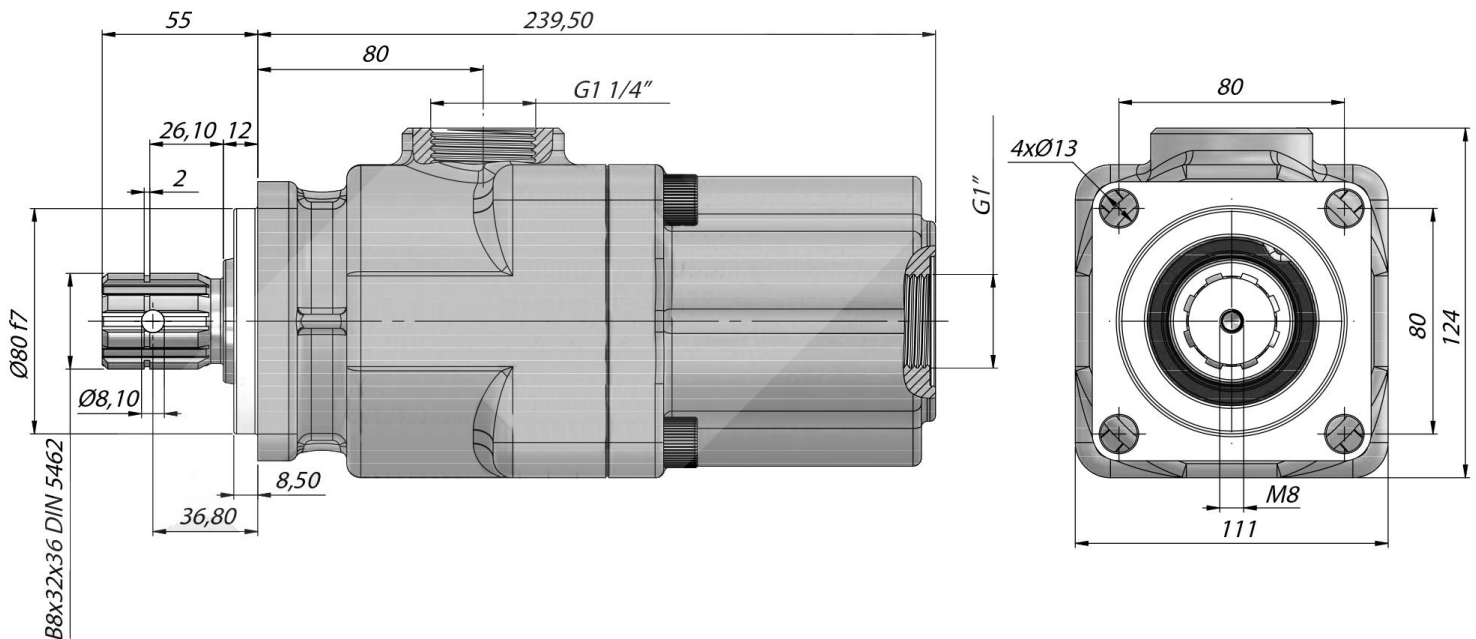

Weight:	41,5 L/min
Flow:	14 kg
Max. constant pressure:	350 bar
Max. intermittent pressure (20 sec):	370 bar
Max. current pressure (6 sec):	400 bar
Max. constant revolutions:	1800 rpm
Min. revolutions:	300 rpm
Suction thread:	1 1/4"
Pressure thread:	1"
Direction of rotation:	DA
Number of pistons:	8